



TREKHAKEN • ATTELAGES • ANHÄNGERVORRICHTUNGEN • TOWBARS • ENHANCES • ANHÆNGERTRÆK • GANCI DI TRAINO

Montagehandleiding | instructions de montage | Einbauanleitung | Mounting instruction
Instrucciones de montaje | monteringsvejledning | istruzioni di montaggio



Nissan Ariya (FE0)
07/'21-

✓ **KICKSENSOR (HANDSFREE TAILGATE)**

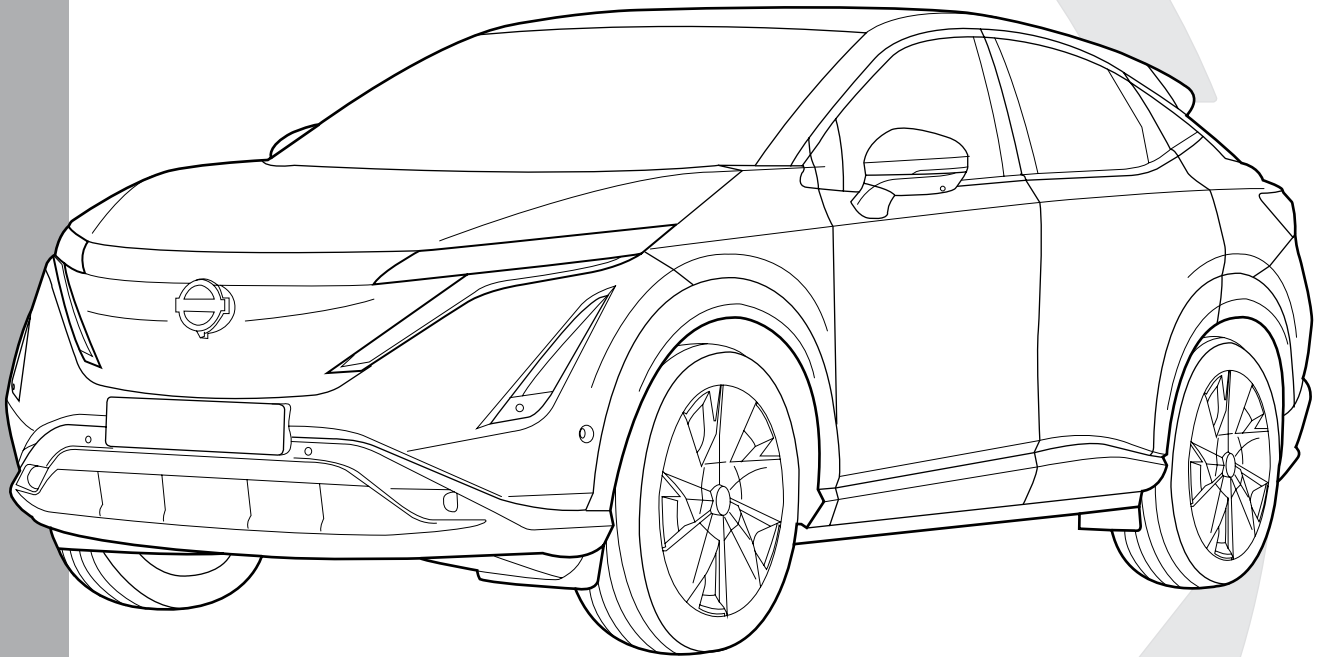

NL Belangrijke raadgevingen

Montage

- Voor de montage moet de trekhaak eerst op het voertuig gepresenteerd worden.

De belasting van een aanhangwagen en van een accessoire dat op de koppelingskogel wordt voorzien, zijn anders van aard. Voor beiden kunnen verschillende limieten van toepassing zijn. Hiervoor verwijzen we naar het instructieboekje van de wagen of naar uw concessiehouder.

FR Recommandations importantes

Montage

- Présenter l'attelage sous le véhicule avant d'effectuer le montage.

La charge d'une remorque ou d'un accessoire prévue sur la boule d'attelage, est de nature diverse. Pour ces deux éléments, il peut y avoir des limites d'utilisation. Nous vous recommandons de vous référer à votre livret d'instructions ou de vous renseigner chez votre concessionnaire.

EN General instructions

Fitting

- Present the towbar under the car first to check if all points are right.

The load of a trailer and of an accessory fitted on the towing ball are of a different nature. Different limits may apply to both. For this matter, we refer to the instruction manual of the vehicle or we advise you to contact your concessionaire.

DE Wichtige ratschläge

Montage

- Erst die Anhängerkupplung und das Fahrzeug kontrollieren, danach montieren.

Die Belastung eines Anhängers und eines Zubehörs, die man auf einer Kupplungskugel voraussieht, ist wesentlich anders. Für beide gilt, dass diese unterschiedlich begrenzt sein können. Deswegen möchten wir verweisen auf die Bedienungsanleitung des Fahrzeugs oder auf Ihren Vertragshändler.

ES Instrucciones generales

Montaje

- Presentar el enganche debajo del vehículo antes de realizar el montaje.

La carga de un remolque y un accesorio montado en una bola de remolque son de una naturaleza diferente. Se pueden aplicar diferentes límites a ambos. Para este asunto, nos referimos al manual de instrucciones del vehículo o le recomendamos que contacte a su distribuidor.

DK Generelle instruktioner

Montering

- Præsenter trækstangen under bilen først for at kontrollere, om alle punkter er rigtige.

Belastningen af en trailer og af tilbehør tilkoblet anhængertrækket er forskellige. Der kan være forskellige begrænsninger på begge. I disse tilfælde henviser vi til bilens manual, eller anbefaler dig at kontakte bilforhandleren

IT Consigli importanti

Montaggio

- In primo luogo, presentare la struttura sotto l'automobile per verificare che tutti i punti di attacco coincidano.

La massa rimorchiabile del veicolo potrebbe essere diversa dal valore riportato sul documento del gancio di traino. Per questo motivo, vi invitiamo a consultare sempre la carta di circolazione del veicolo (Pos. O.1) o a rivolgervi alla vostro concessionario di fiducia

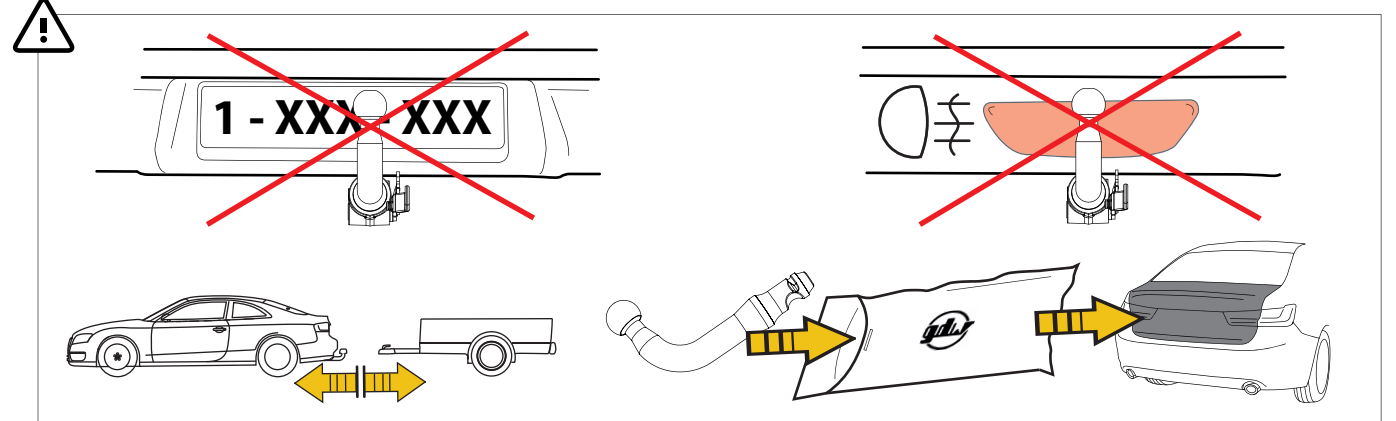
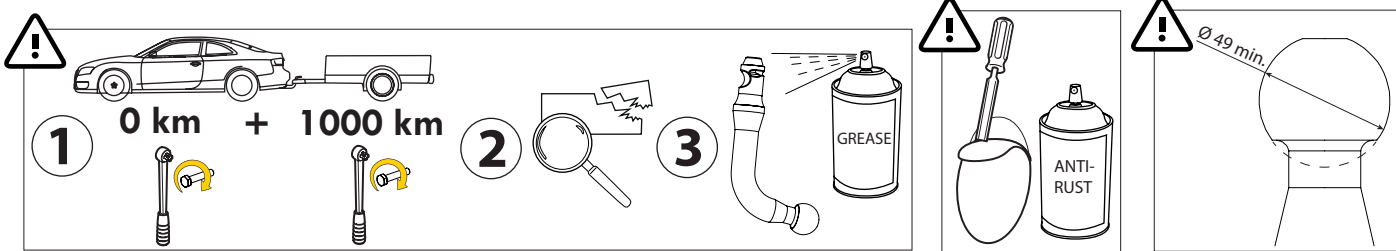
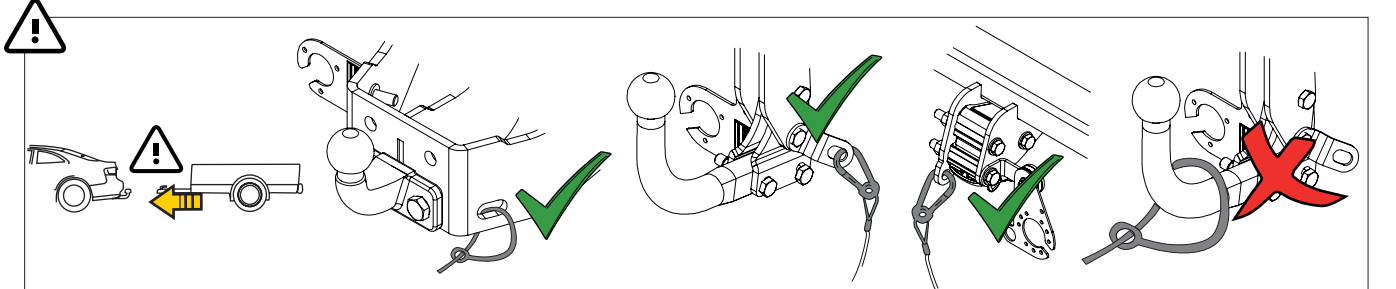
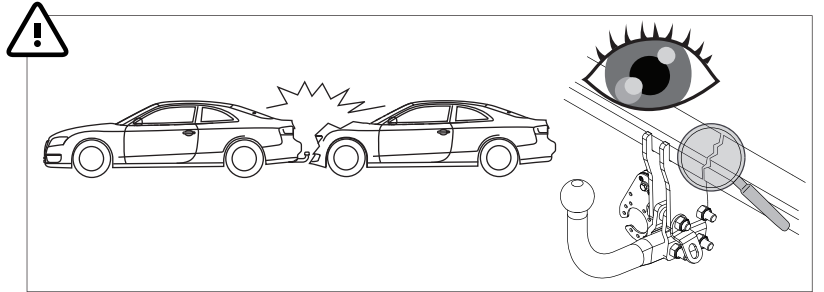
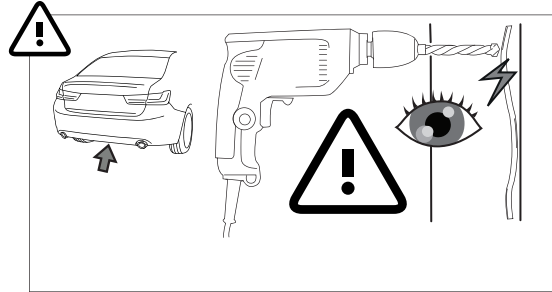
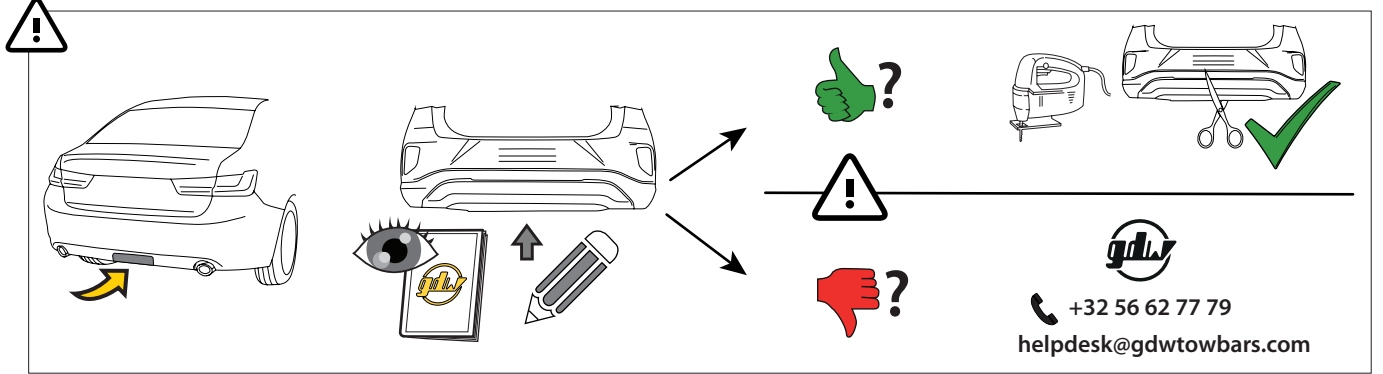
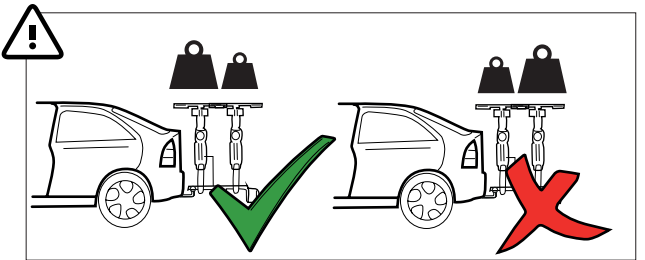
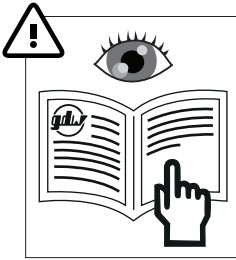
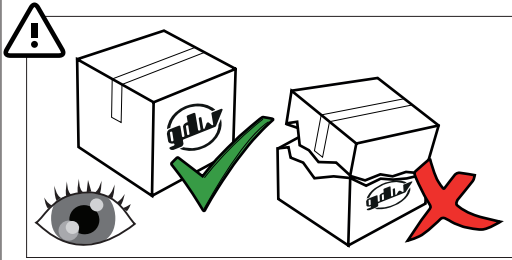

MADE BY



D 9,50

F

E6

BELGIUM

S 80

EC-N°

55R-02 1766

REF N°

2725

SERIAL N°

XXXX

DESCRIPTION

Nissan Ariya



$$D = \frac{\text{max kg (car)} \times \text{max kg (trailer)}}{\text{max kg (car)} + \text{max kg (trailer)}} \times 0.00981 \leq 9,50 \text{ kN}$$

$$S = \text{max kg (hook)} \leq 80 \text{ kg} \quad \text{max kg (trailer)} \leq 1500 \text{ kg}$$

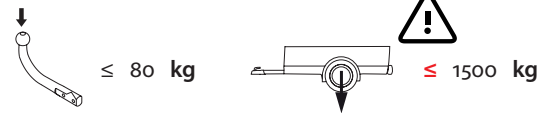

See the Certificate Of Conformity (COC) of your vehicle or contact your dealer to verify the max. trailer weight of your car!

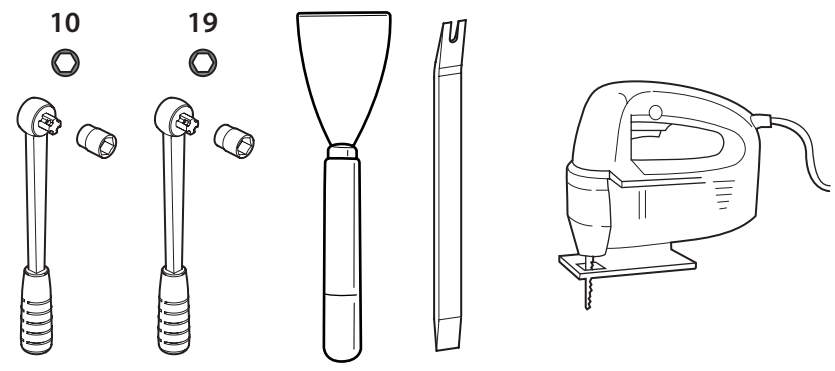
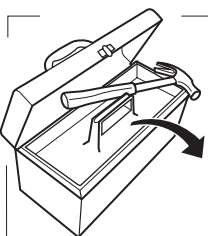
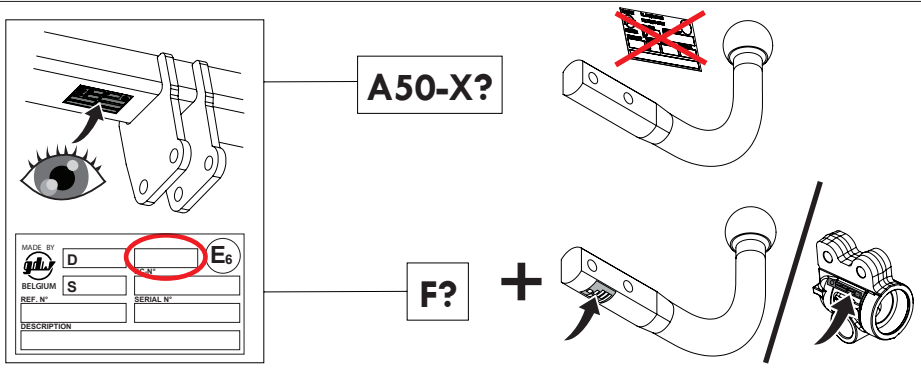
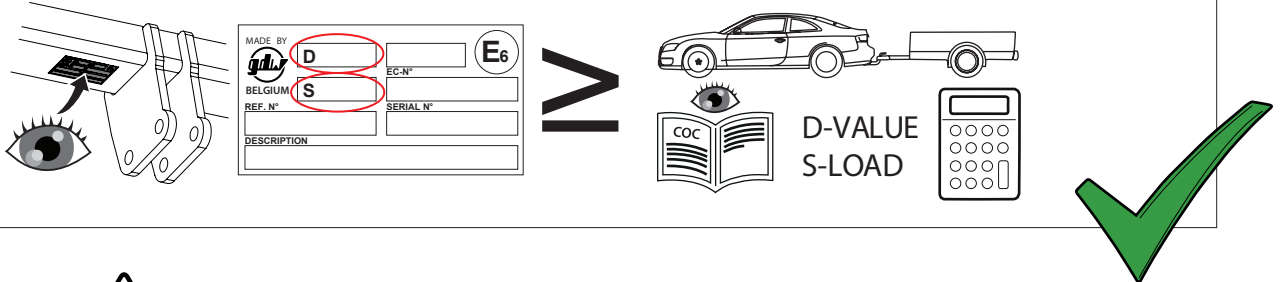
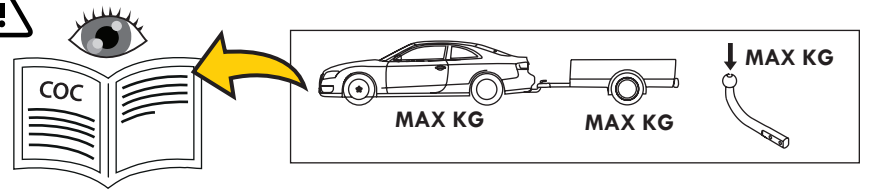









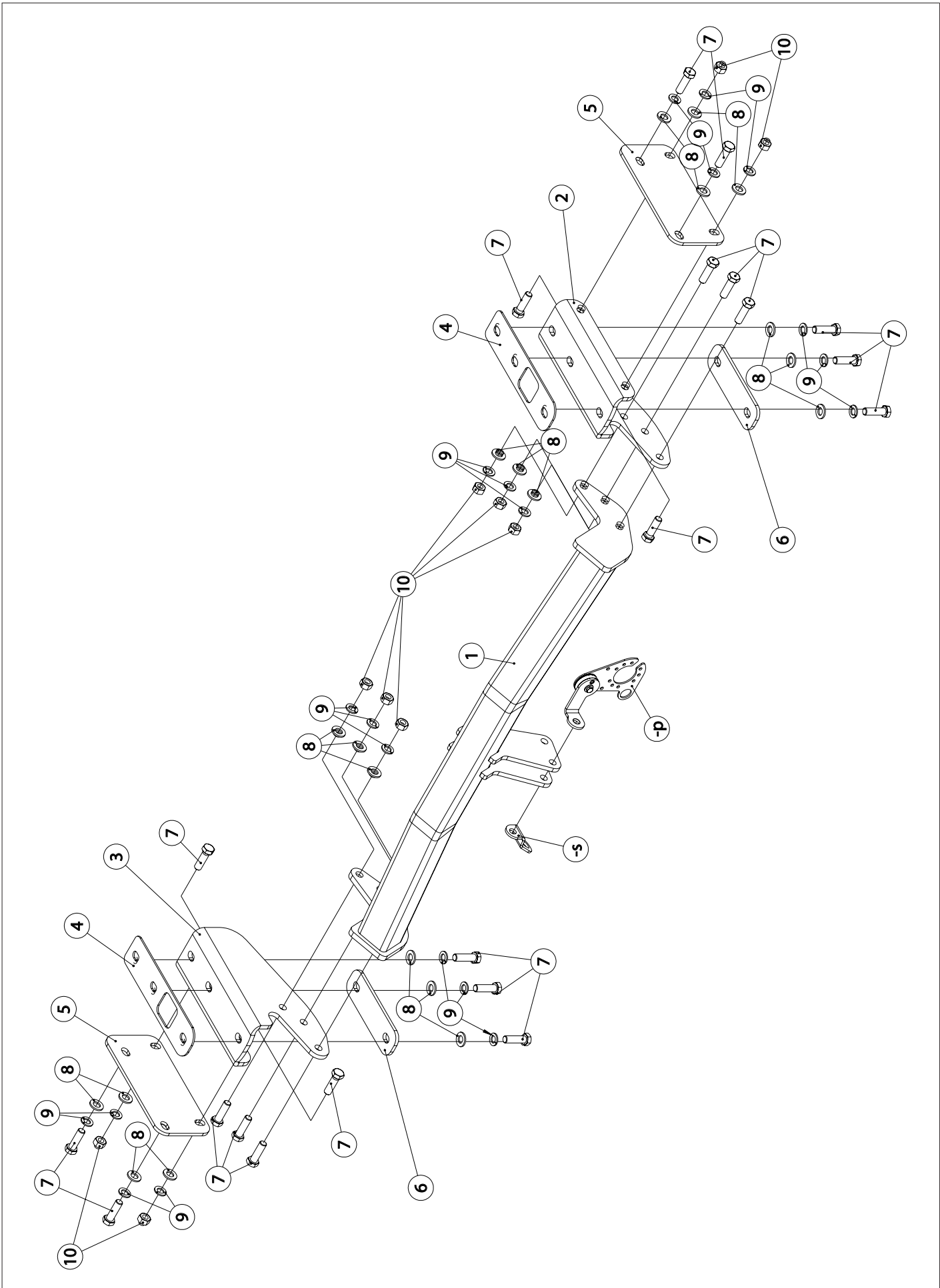

helpdesk@gdwtowbars.com

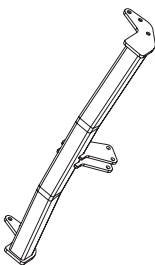
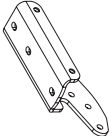
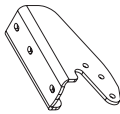
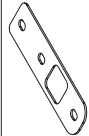
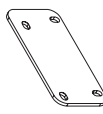
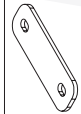





+32 56 62 77 79



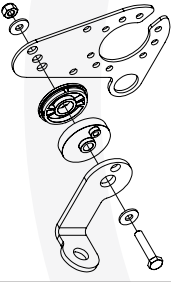

| | | |
|-----------|---------------|---------------|
| Monday | 08:00 - 12:00 | 12:30 - 16:30 |
| Tuesday | 08:00 - 12:00 | 12:30 - 16:30 |
| Wednesday | 08:00 - 12:00 | 12:30 - 16:30 |
| Thursday | 08:00 - 12:00 | 12:30 - 16:30 |
| Friday | 08:00 - 12:00 | 12:30 - 15:30 |

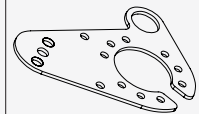

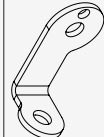

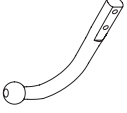
| | | | |
|----|---|-----|-----------------------|
| 1 |  | X1 | GDW REF. 2725 |
| 2 |  | X1 | GDW REF. 2 |
| 3 |  | X1 | GDW REF. 3 |
| 4 |  | X2 | GDW REF. 4 |
| 5 |  | X2 | GDW REF. 5 |
| 6 |  | X2 | GDW REF. 6 |
| 7 |  | X20 | DIN961-M12X1.25X40 |
| 8 |  | X20 | DIN125-A12-140HV-ELVZ |
| 9 |  | X20 | DIN128A-M12 |
| 10 |  | X10 | DIN934-M12X1,25 |
| 11 |  | X4 | GDW REF. 11 |
| 12 |  | X4 | GDW REF. 12 |
| -5 |  | X1 | GDW REF. 900.053 |

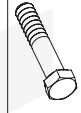
| | | | |
|----|---|----|--------------------------|
| -P |  | X1 | GDW REF. P46 |
| L |  | X1 | DIN985-M6 |
| L |  | X2 | 6,2 X 15,4 X 1,6 (NYLON) |
| L |  | X1 | GDW REF. 718.16.002 |
| L |  | X1 | GDW REF. 718.16.003 |
| L |  | X1 | GDW REF. 908.094 |
| L |  | X1 | DIN933-M6 X 30 |
| L |  | X1 | GDW REF. 908.101 |

| | | | |
|---|---|----|-----------------------------------|
| Geleverd met - Livré avec - Delivered with Gefleert mit - Elementos adjuntos-Leveres med |  | X1 | 944.M000 |
| |  | X2 | GDW REF. 900.008 |
| |  | X2 | GDW REF. 900.011 Ø 21,3 X 11,7 |
| |  | X4 | DIN931-M12 X 70 |
| |  | X4 | DIN985-M12 |

| | | |
|---|----|------------|
| OPTION T36 | | |
|  | X1 | KIT36-2725 |

1

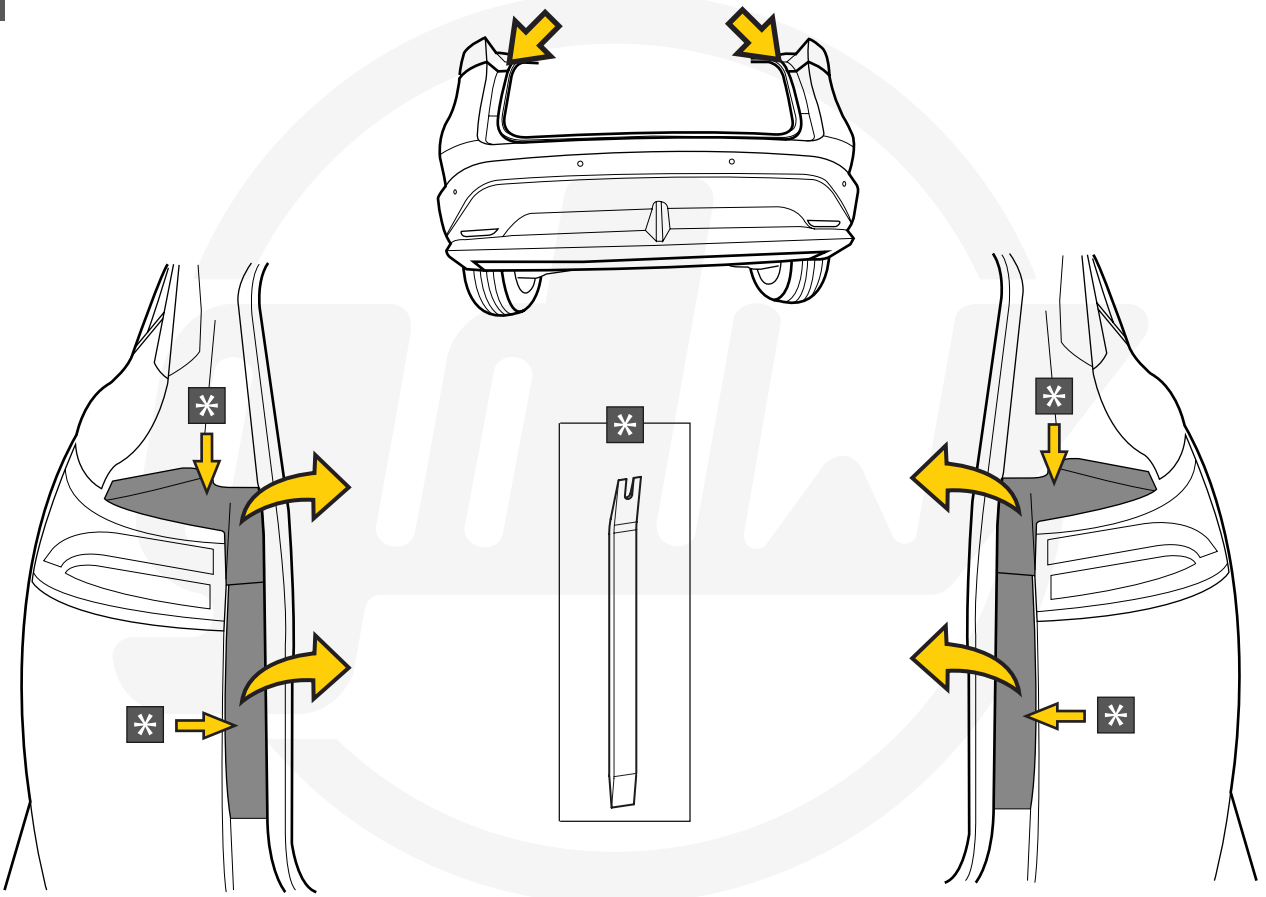

2

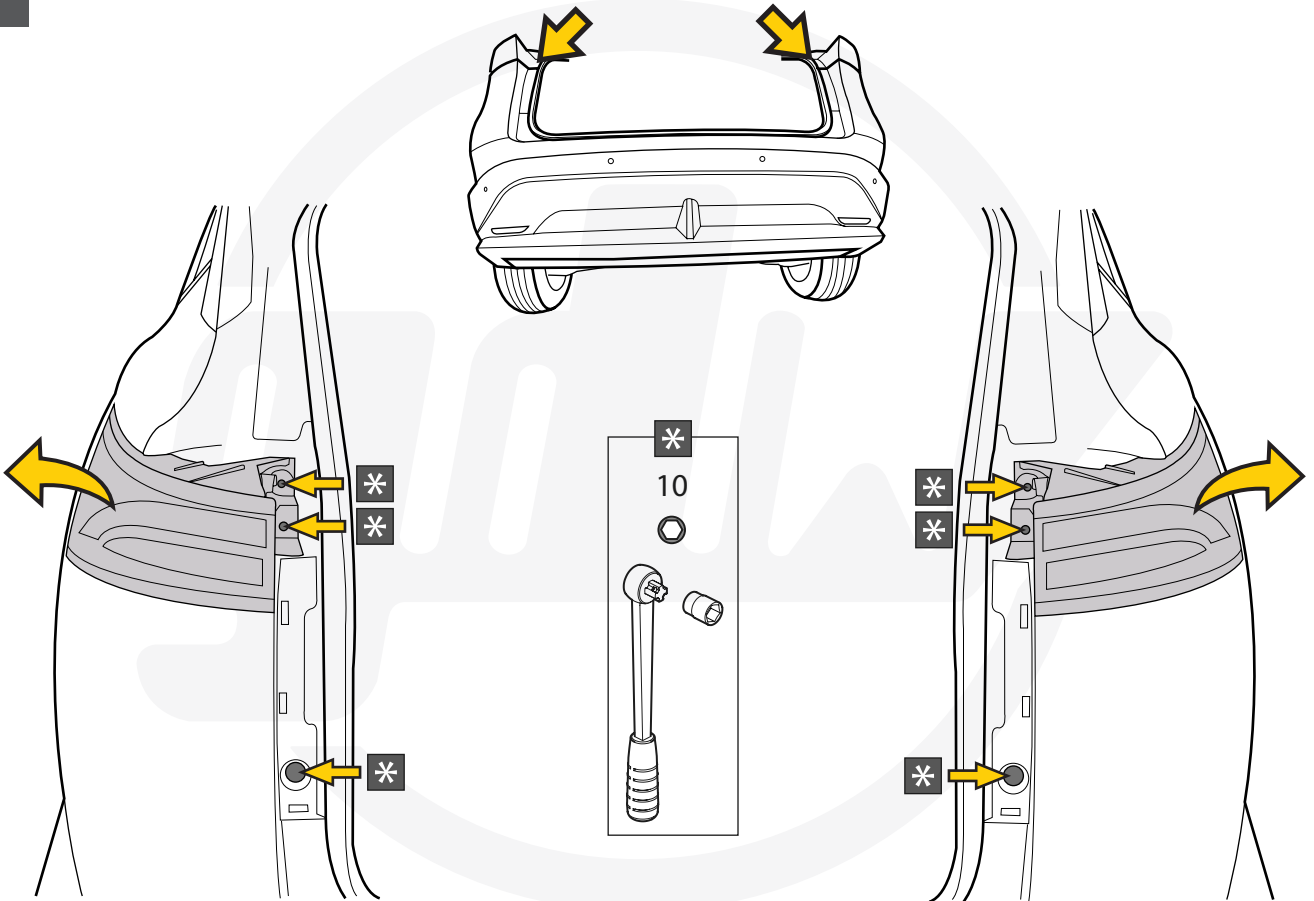

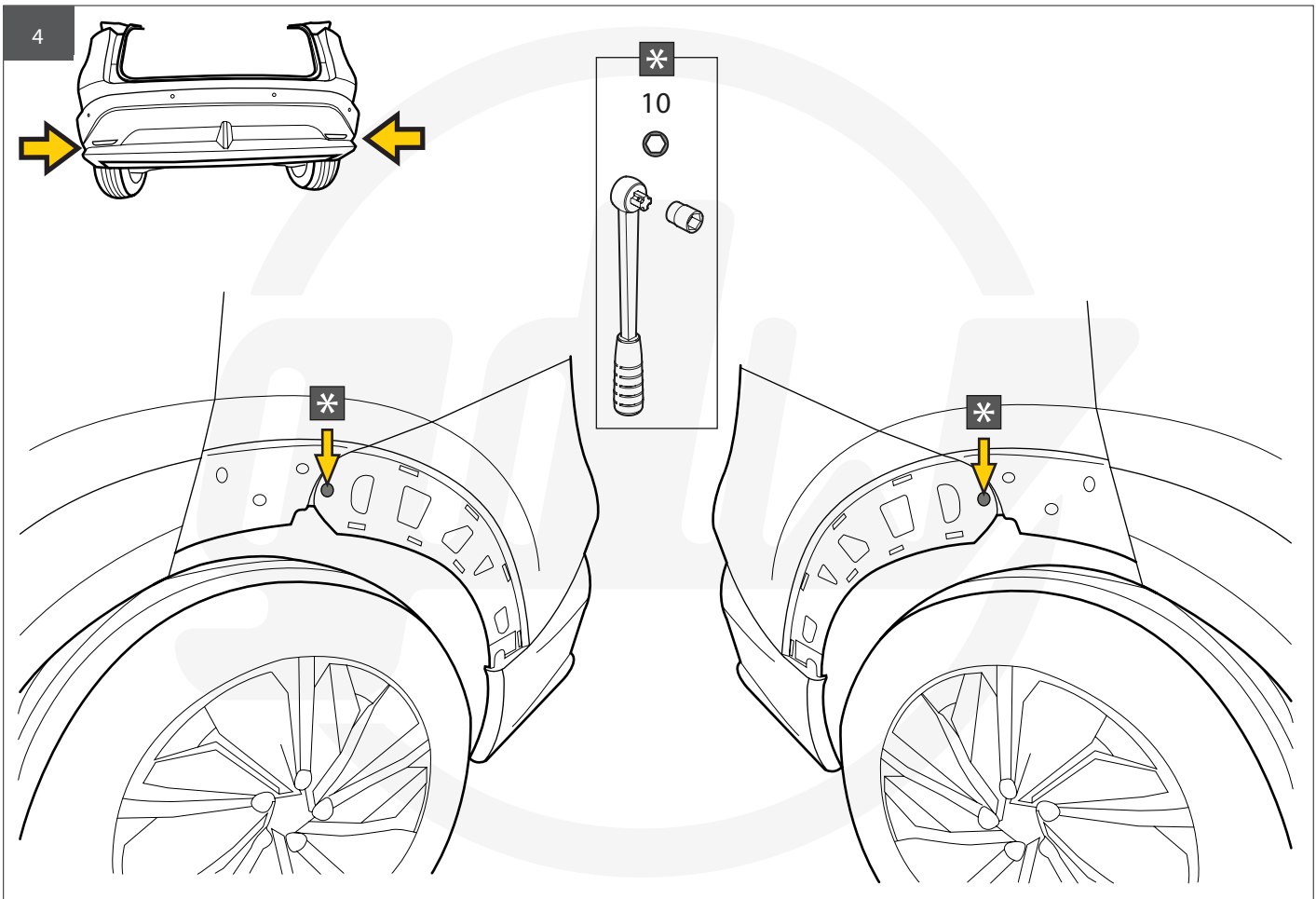
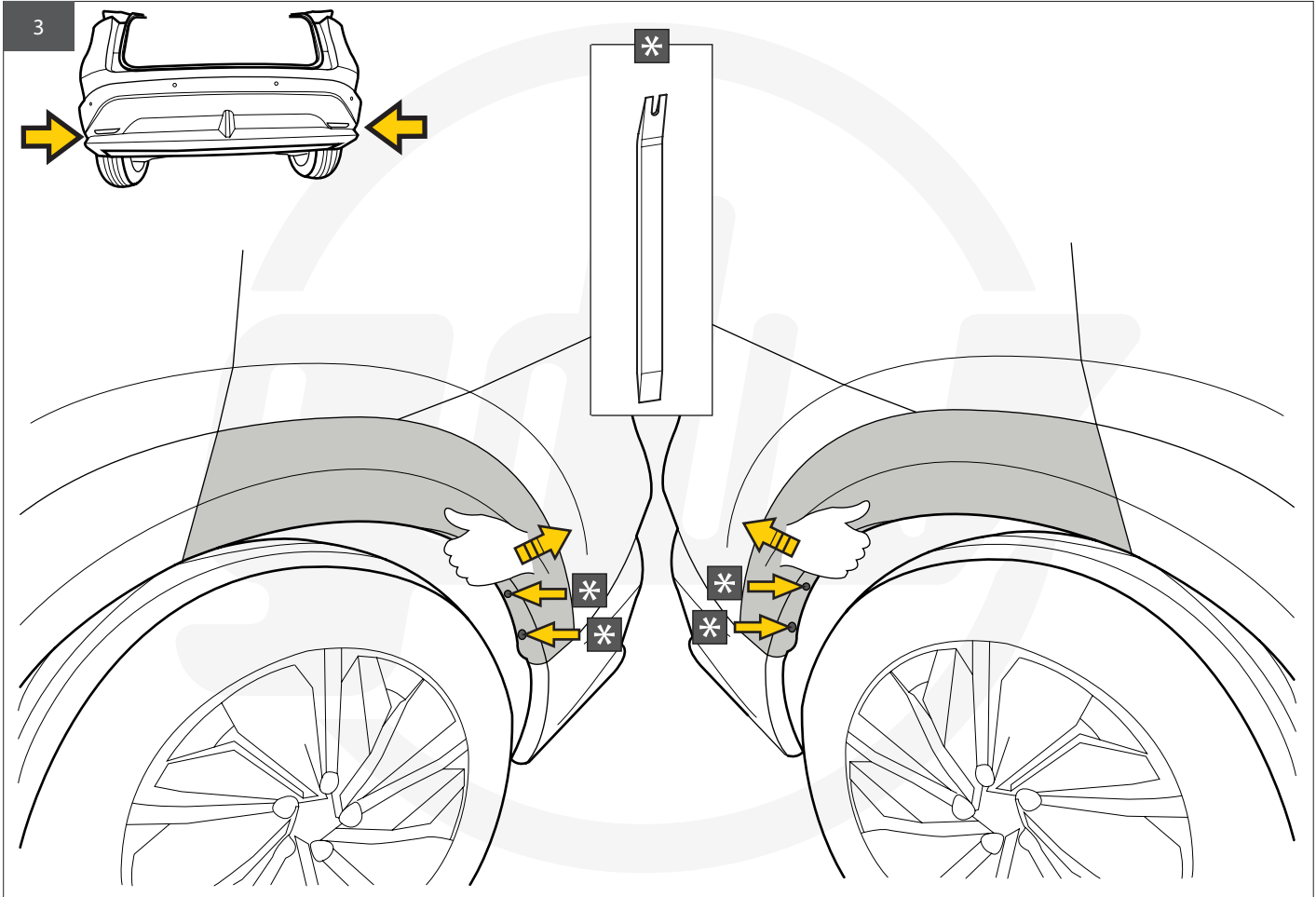

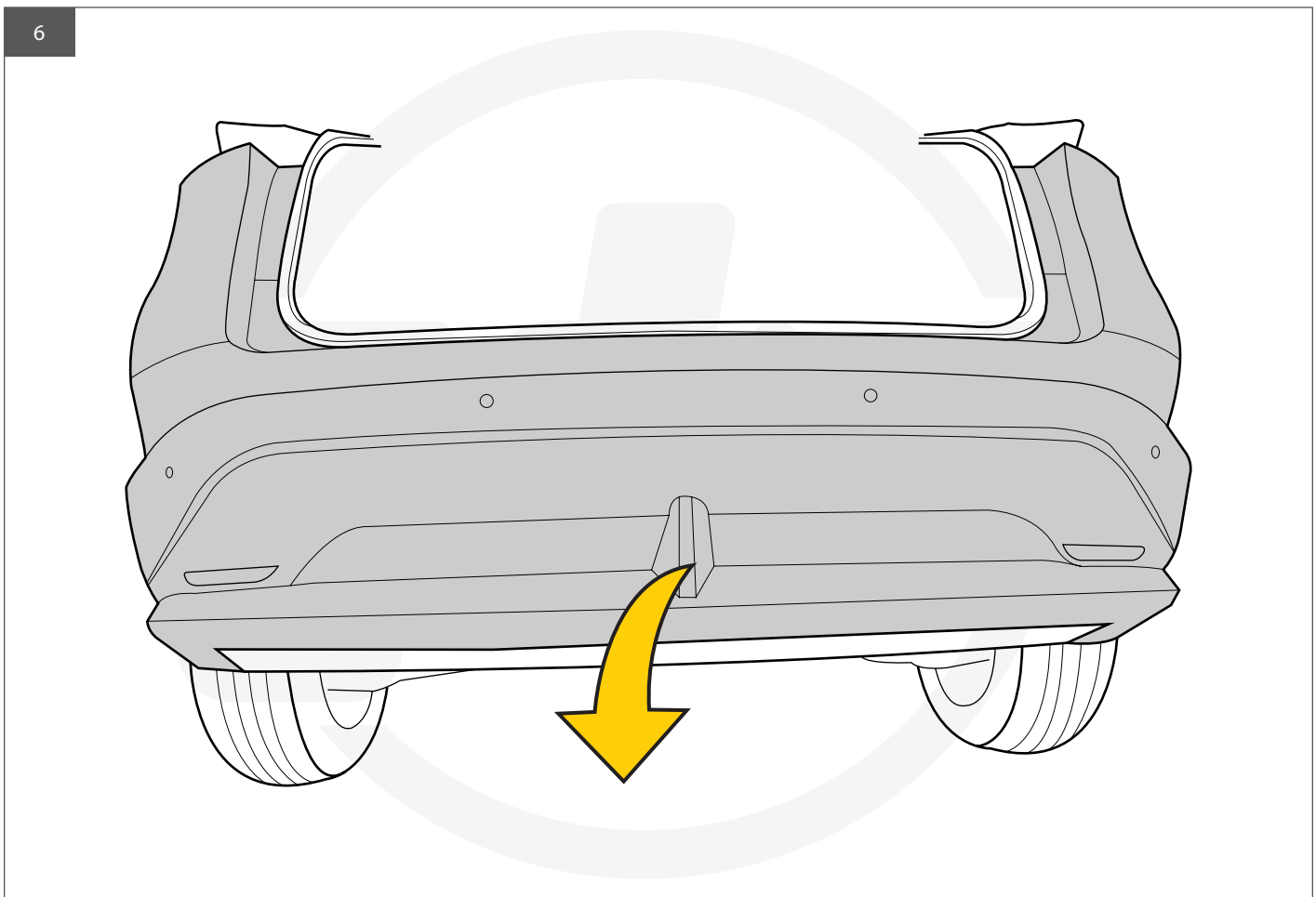
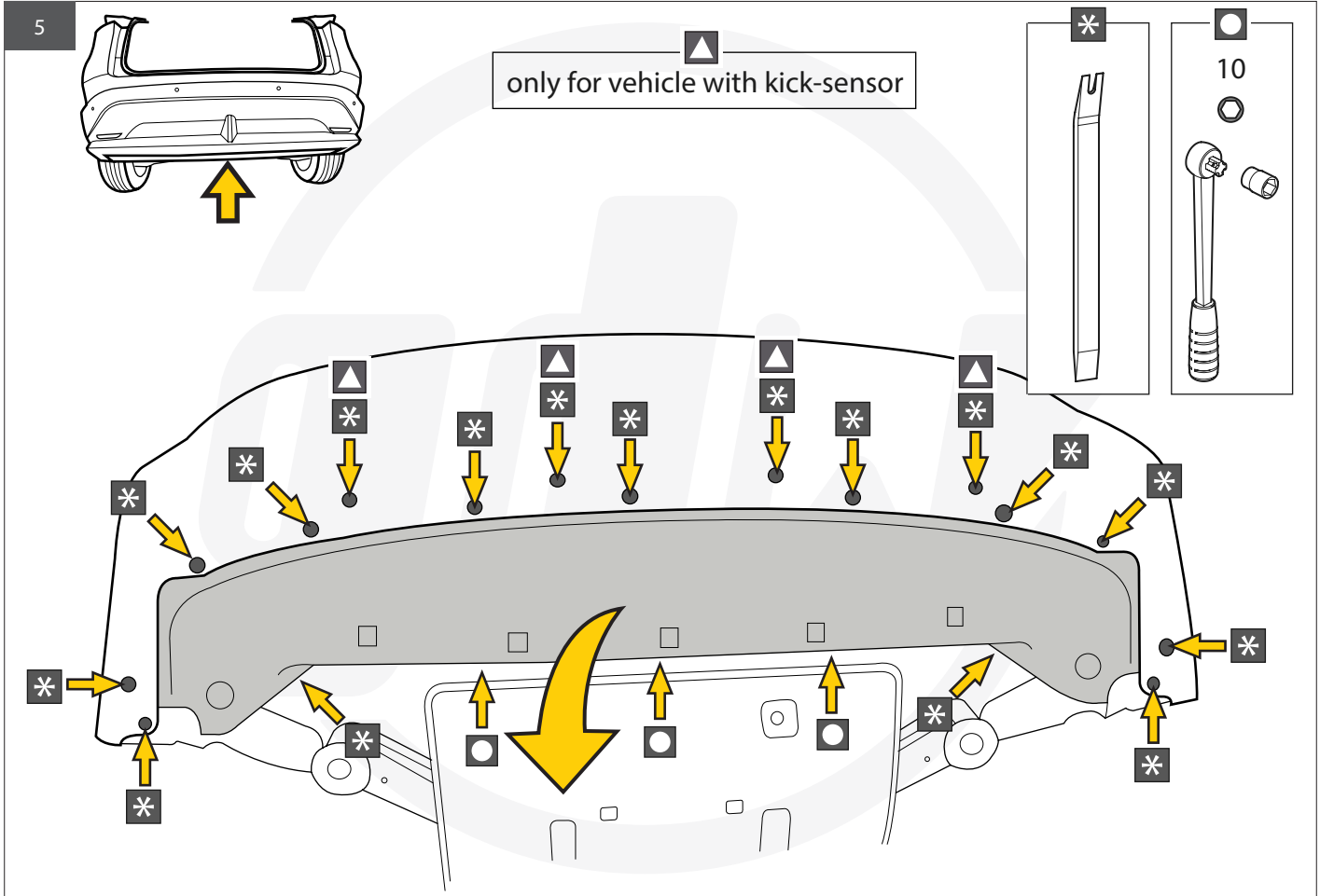

7

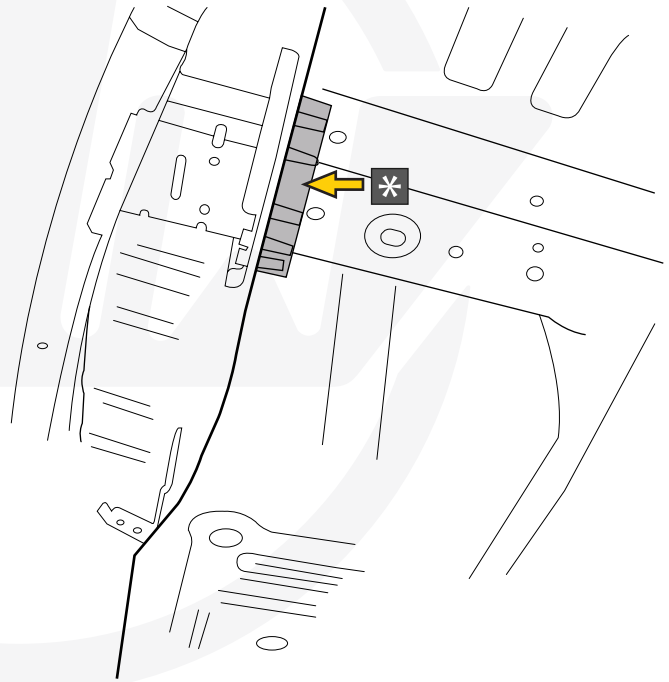
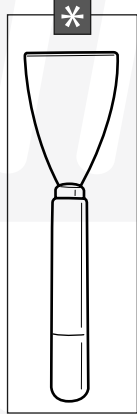
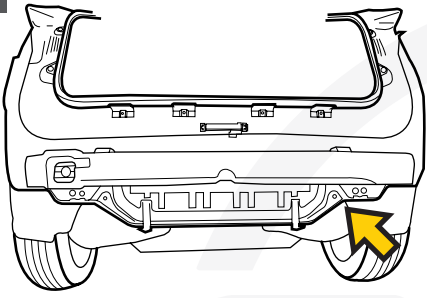

8

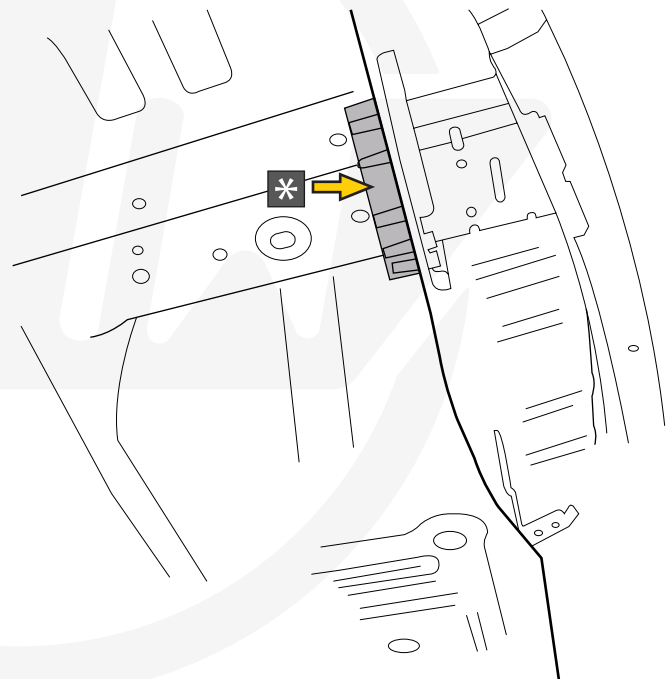
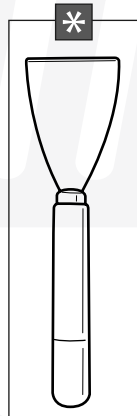
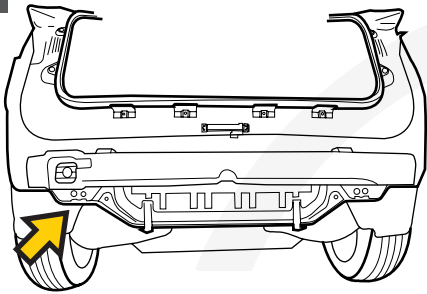

9

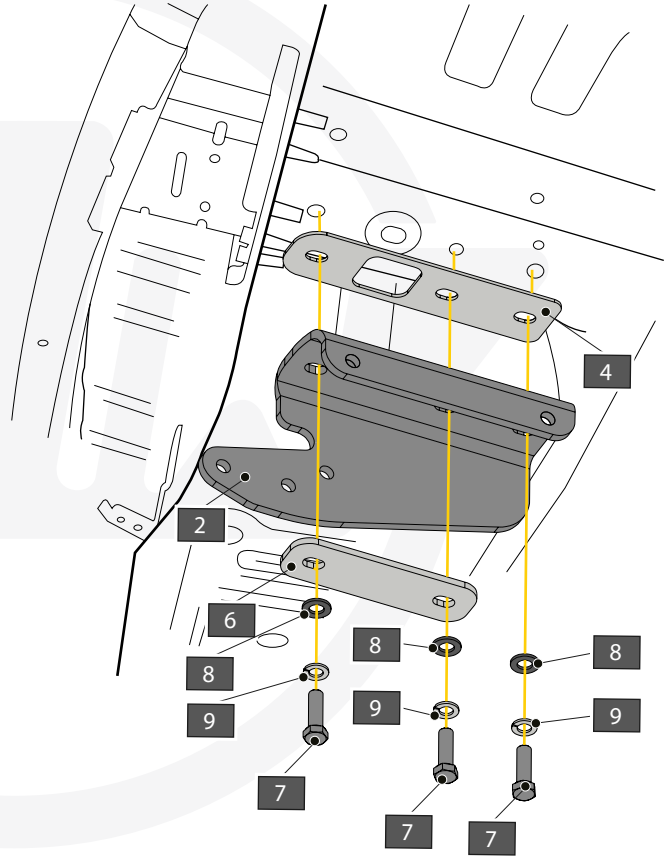
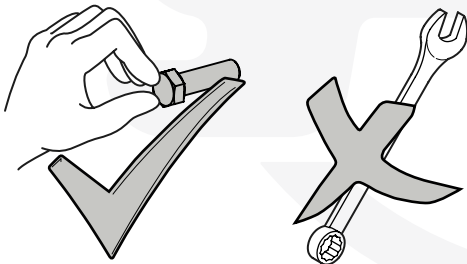
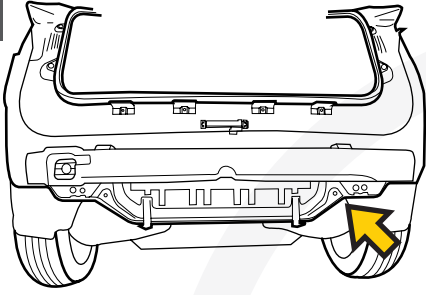

10

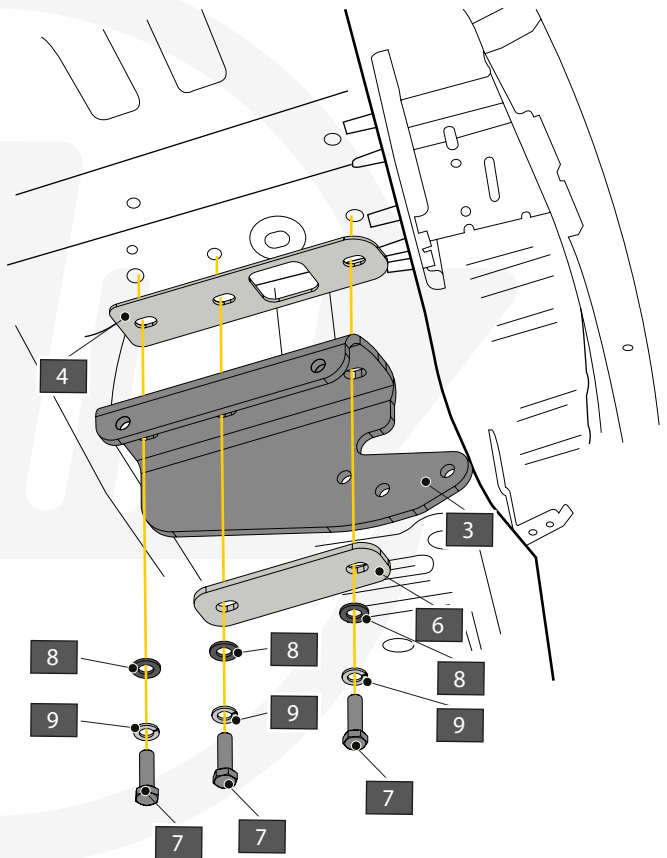
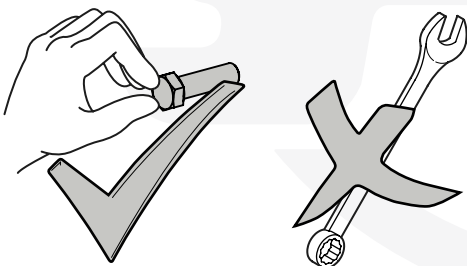
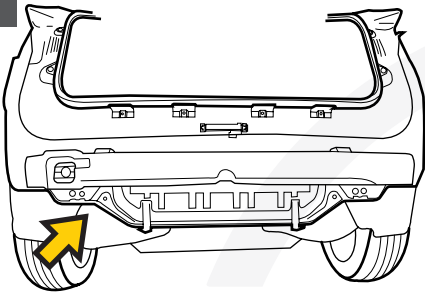

11

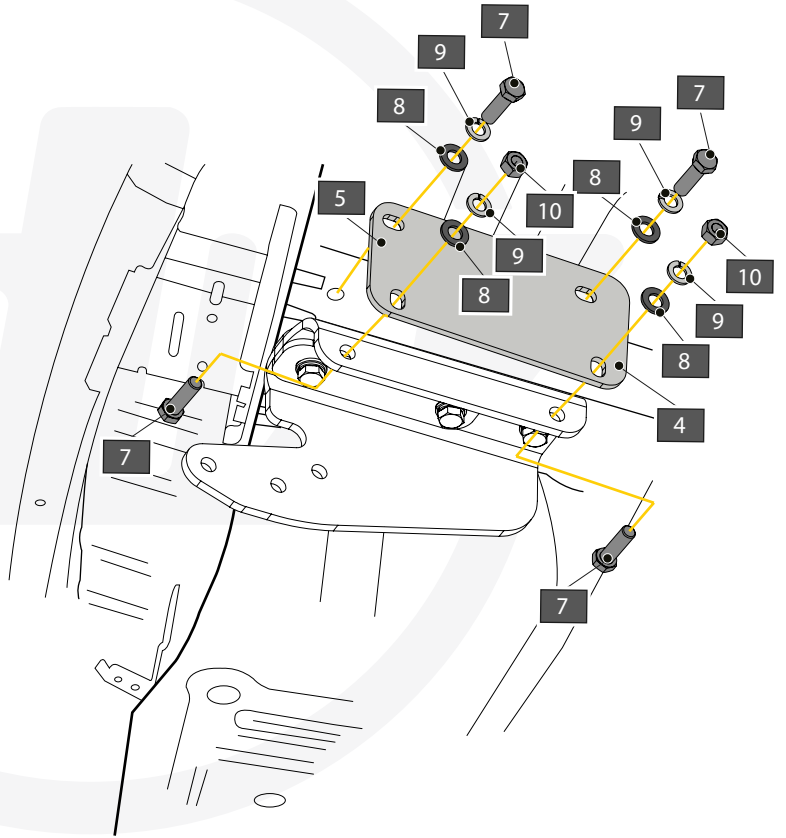
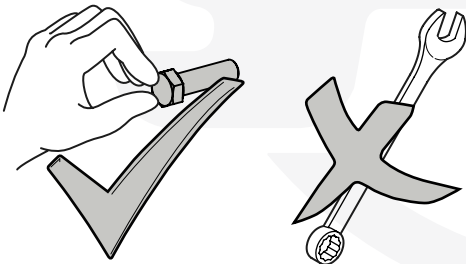
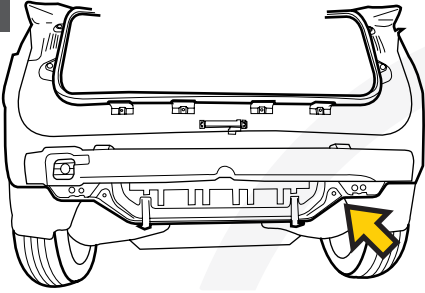

12

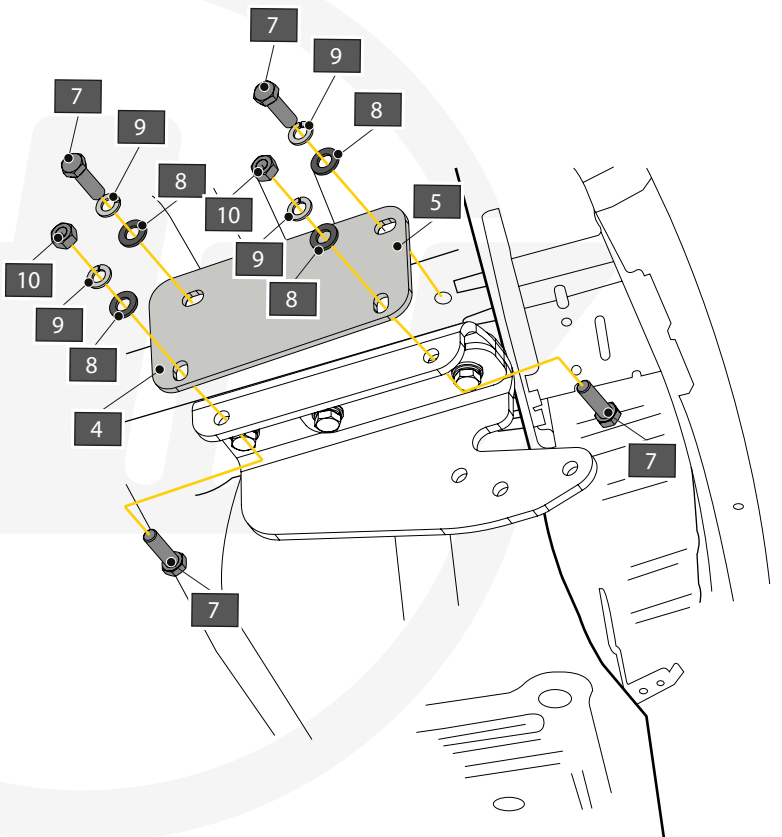
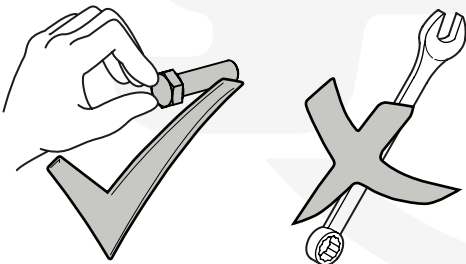
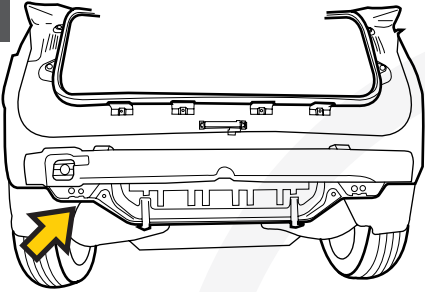

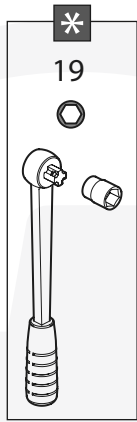
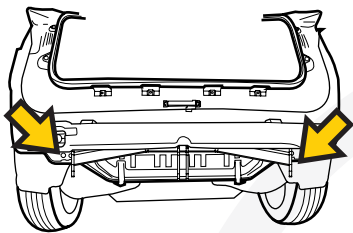
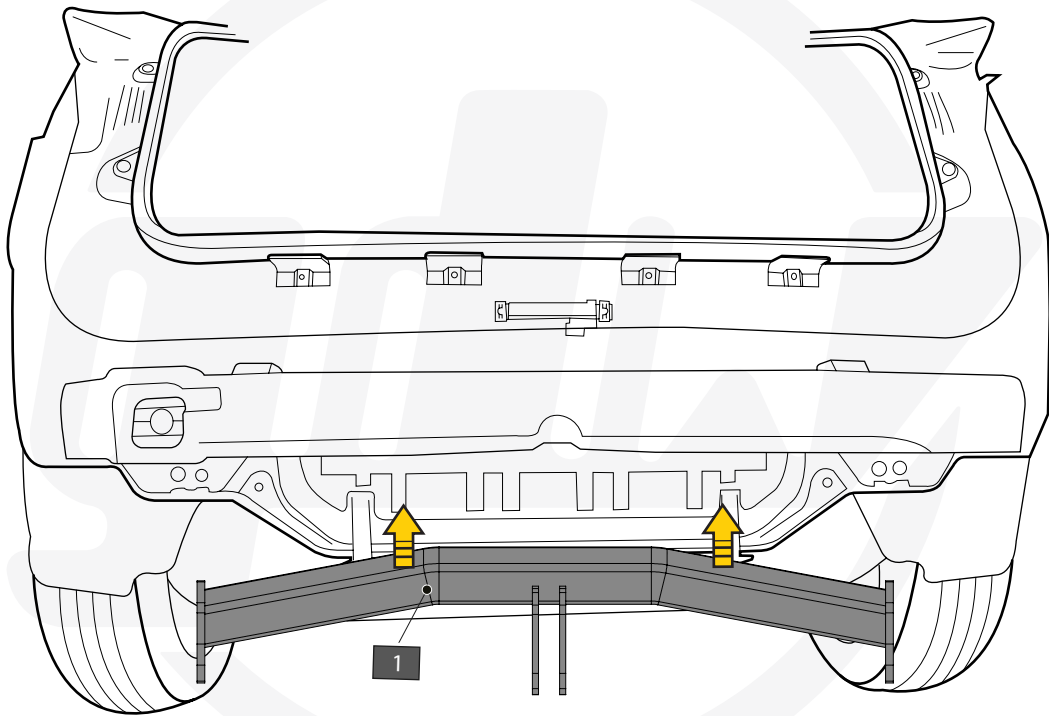

101,0 Nm

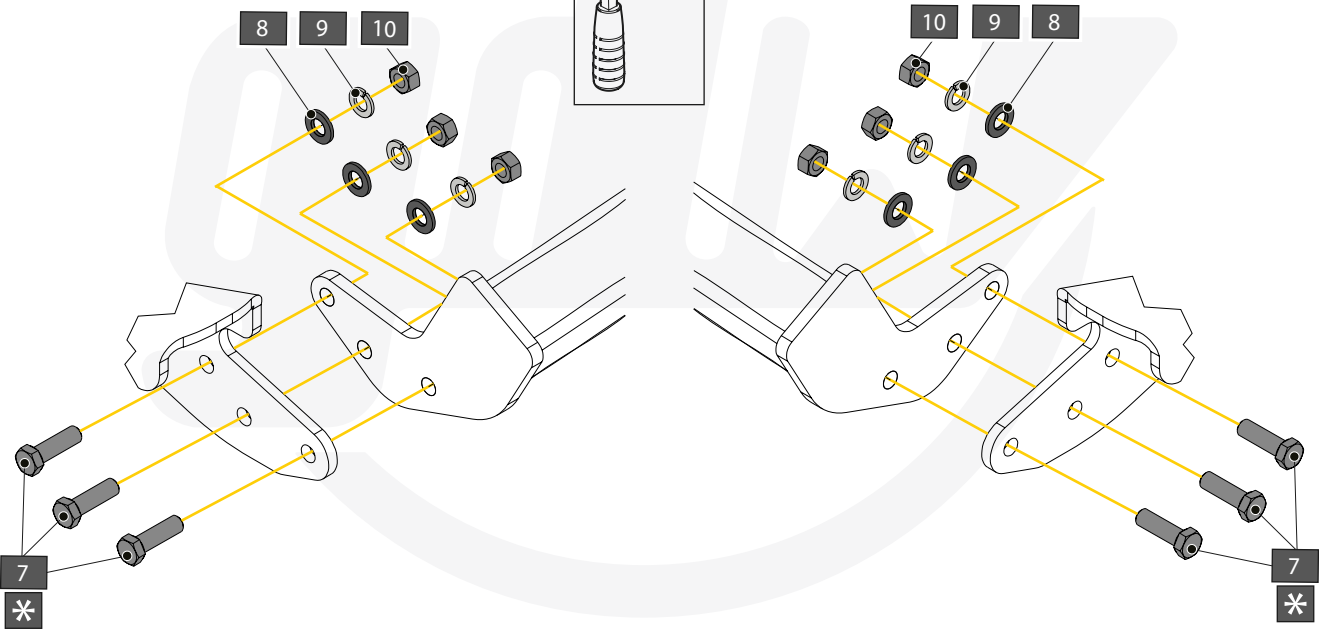

15

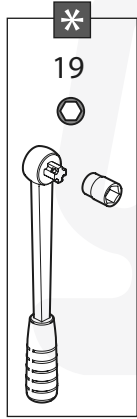
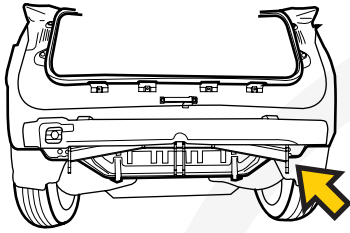

101,0 Nm

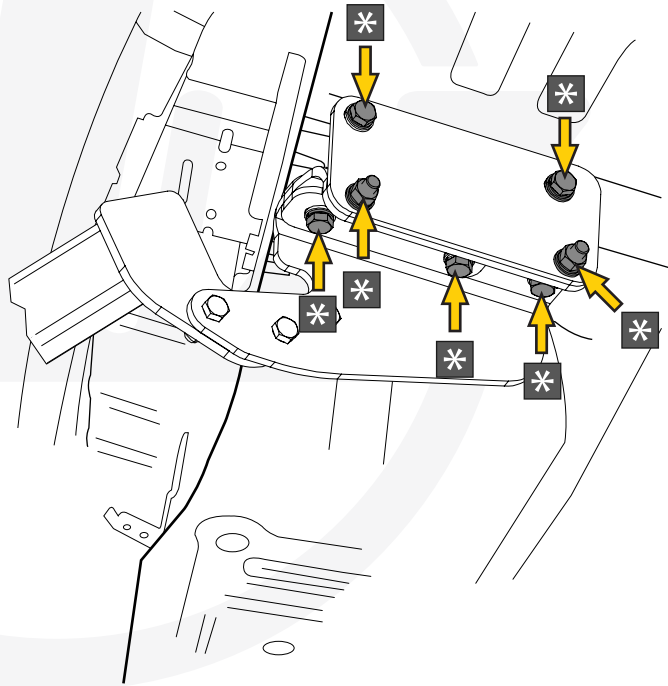

16

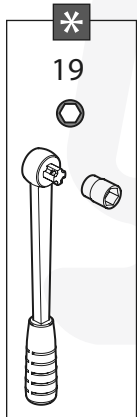
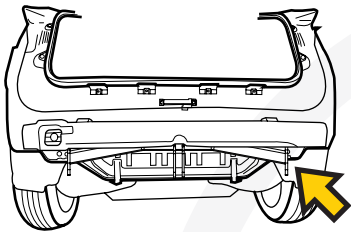

101,0 Nm

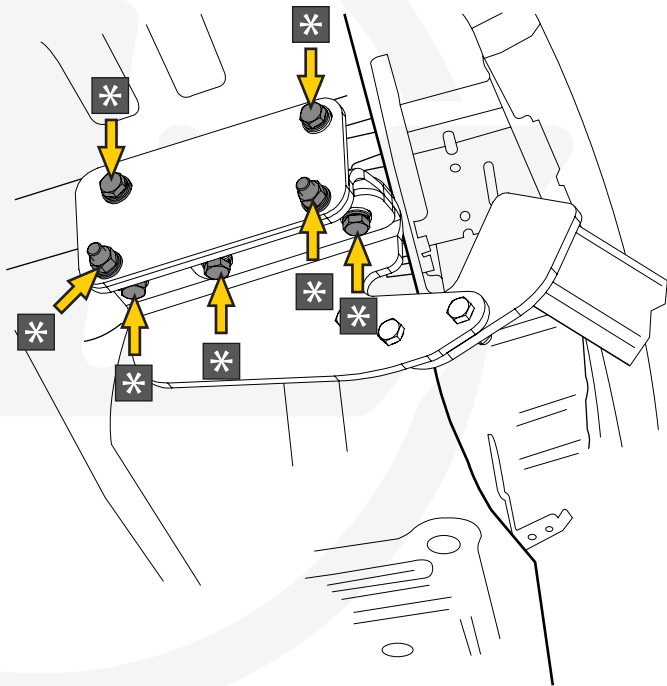

Only for vehicles with Kick-sensor

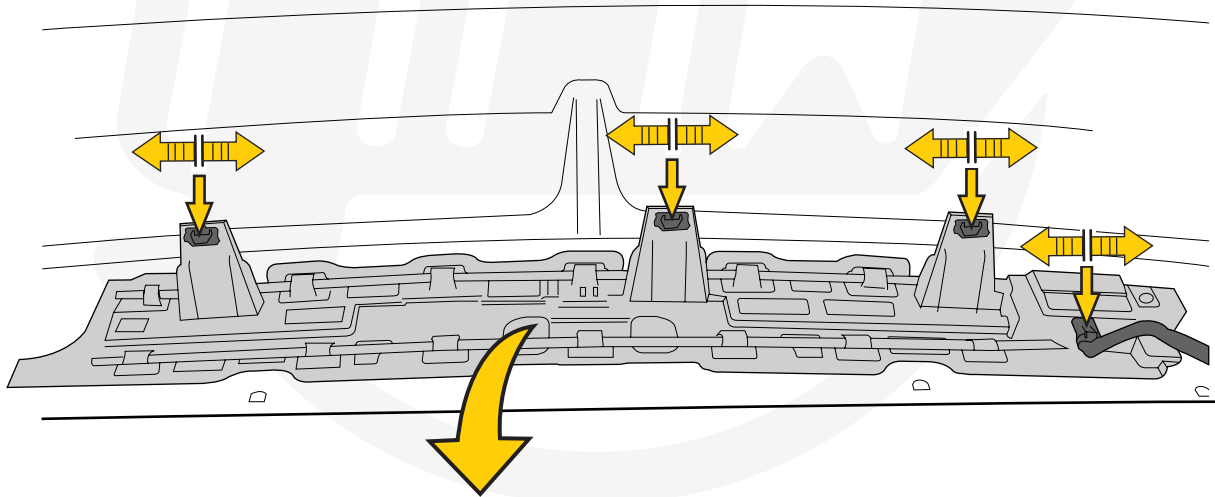

Only for vehicles with Kick-sensor

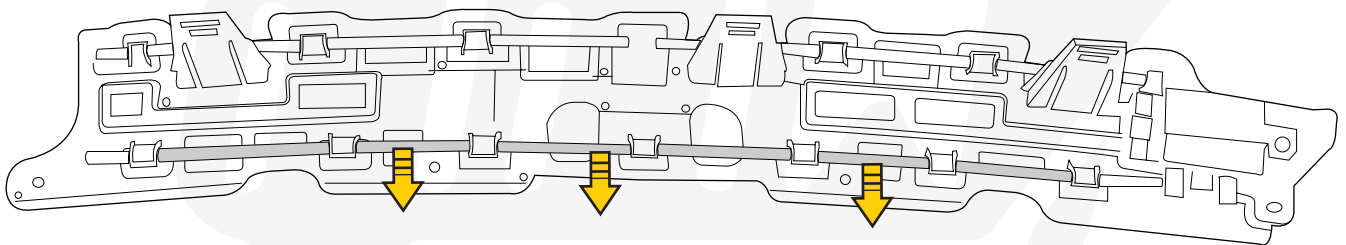

Only for vehicles with Kick-sensor

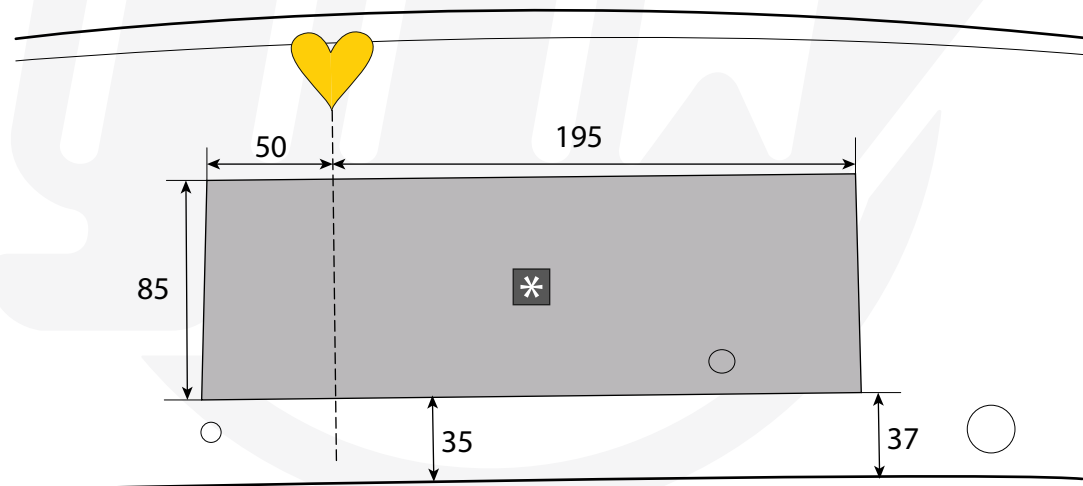
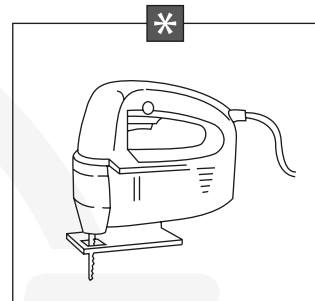
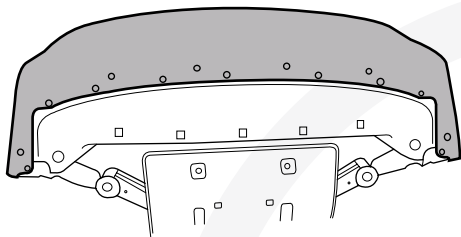
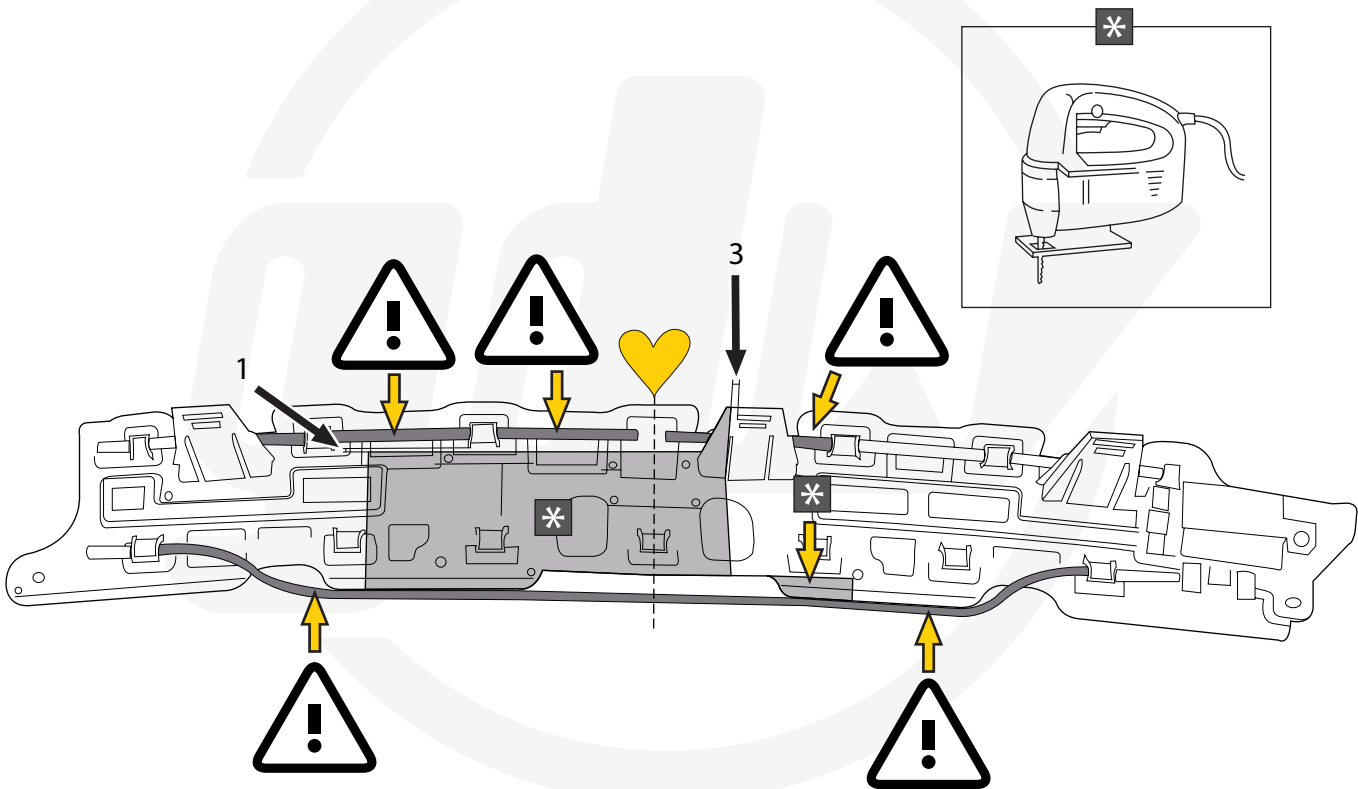

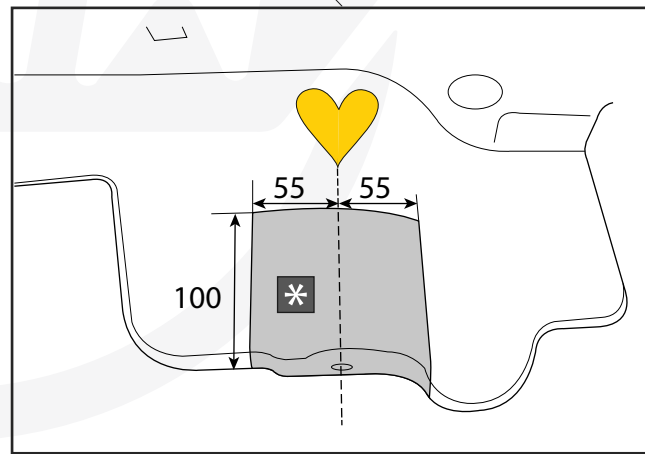
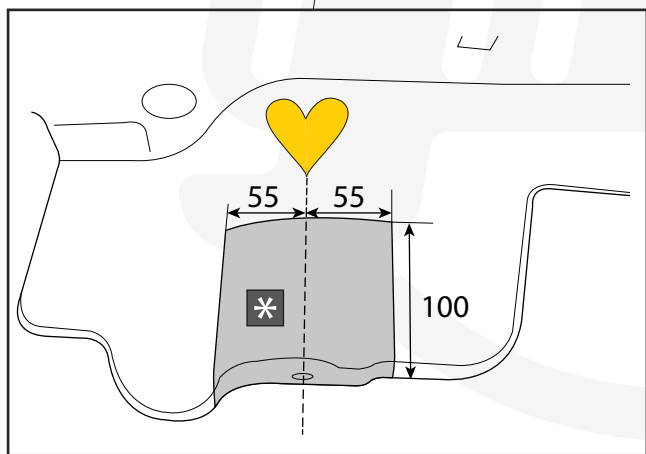
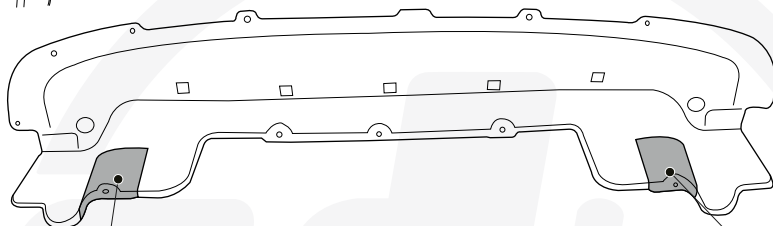
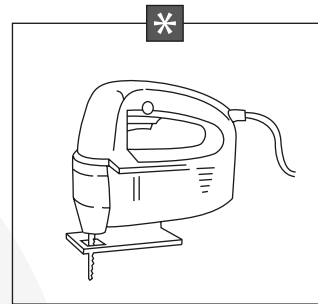
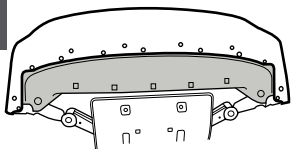

| | | |
|---|--|------------------------------|
| A | | X1 GDW REF. 908.101 |
| B | | X1 DIN985-M6 |
| C | | X2 Ø15,4 X 6,2 X 1,6 (NYLON) |
| D | | X1 GDW REF. 718.16.002 |
| E | | X1 GDW REF. 718.16.003 |
| F | | X1 GDW REF. 908.094 |
| G | | X1 DIN933-M6 X 30 |

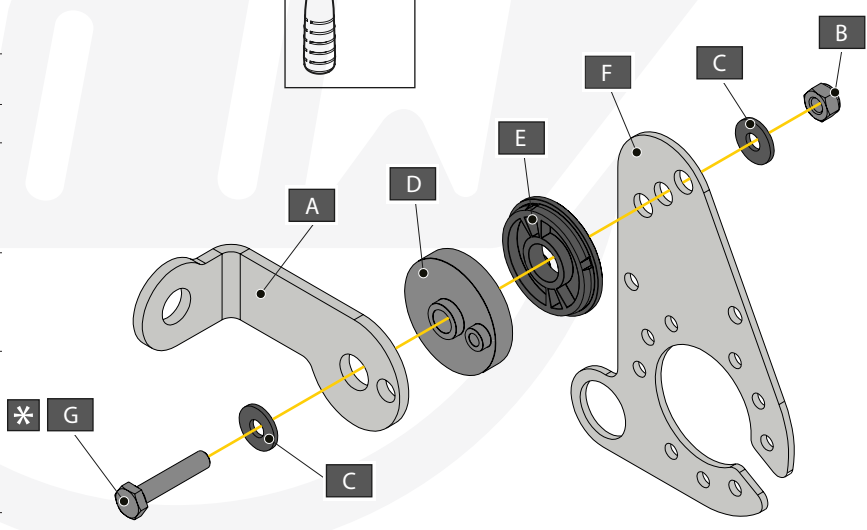
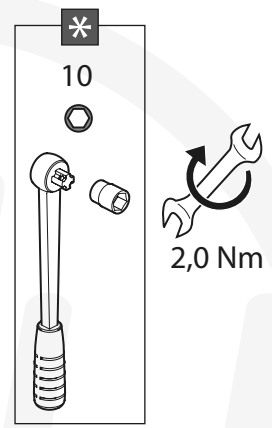

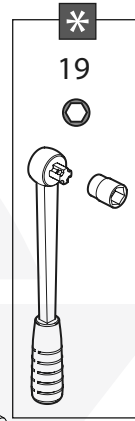
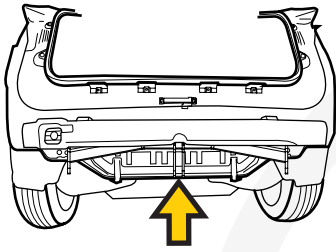

| | | | |
|----|--|----|-----------------------------------|
| A | | X2 | GDW REF. 900.008 |
| B | | X2 | GDW REF. 900.011 Ø 21,3 X 11,7 |
| C | | X2 | DIN931-M12 X 70 -10,9 |
| D | | X2 | DIN985-M12 KL10,9 |
| -S | | X1 | GDW REF. 900.053 |

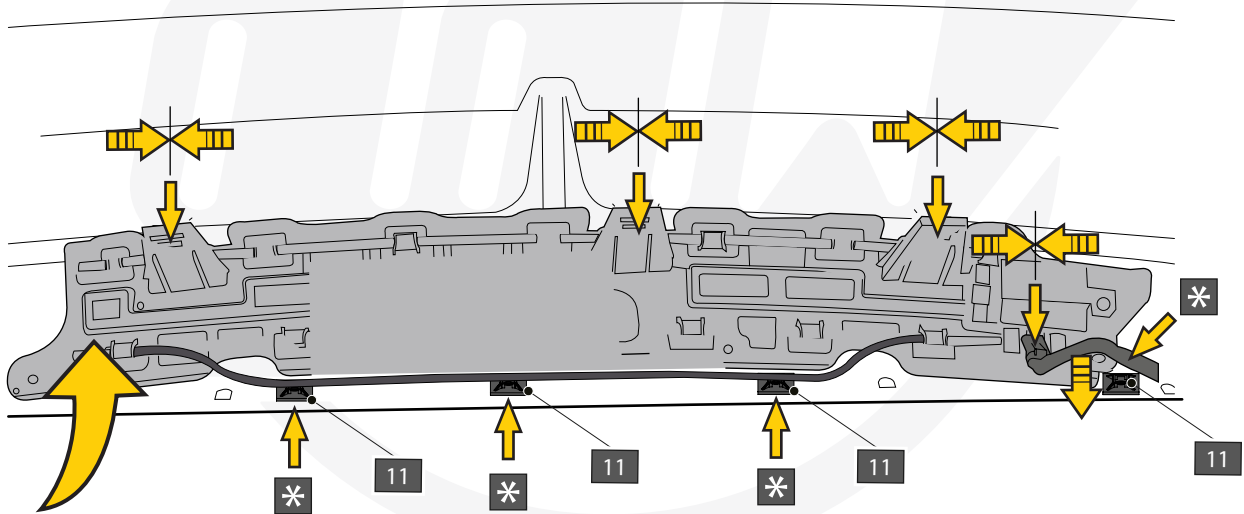
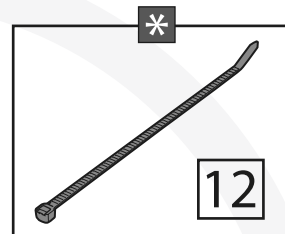
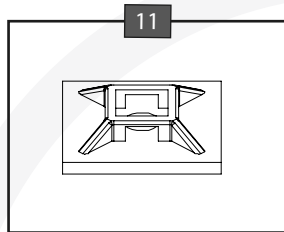
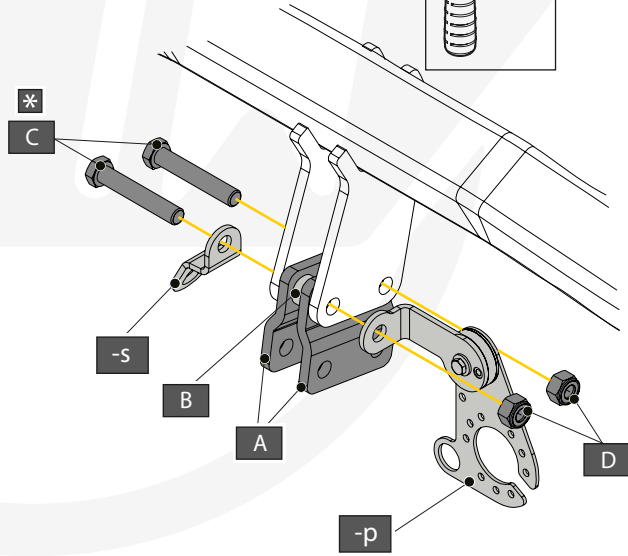

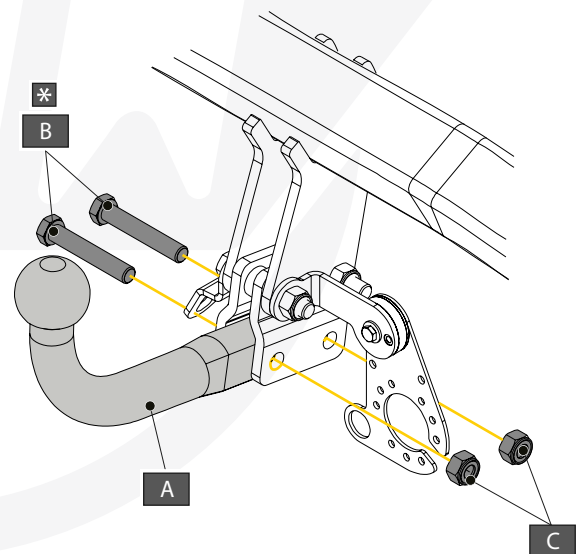
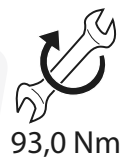
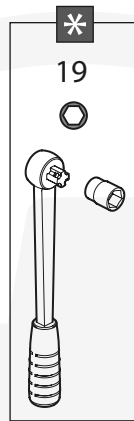
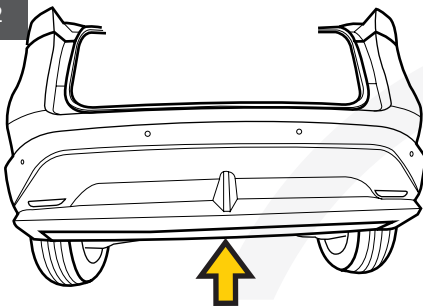
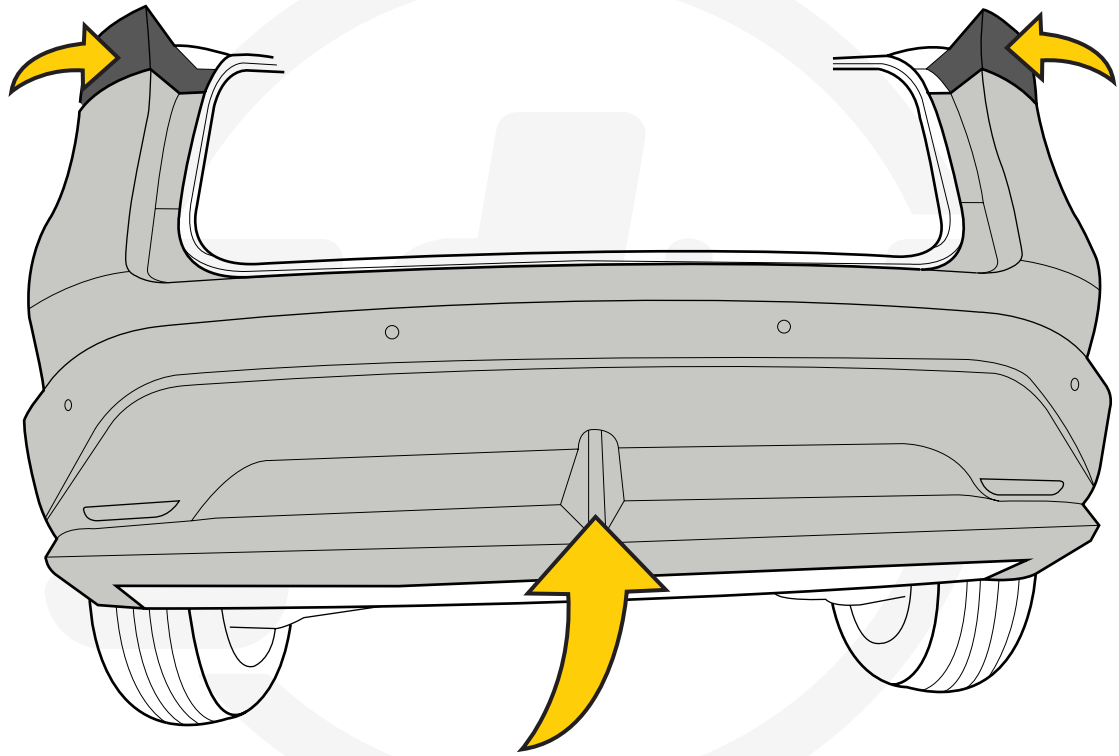

- | | | | |
|---|--|----|-----------------|
| A | | X1 | 944.M000 |
| B | | X2 | DIN931-M12 X 70 |
| C | | X2 | DIN985-M12 |

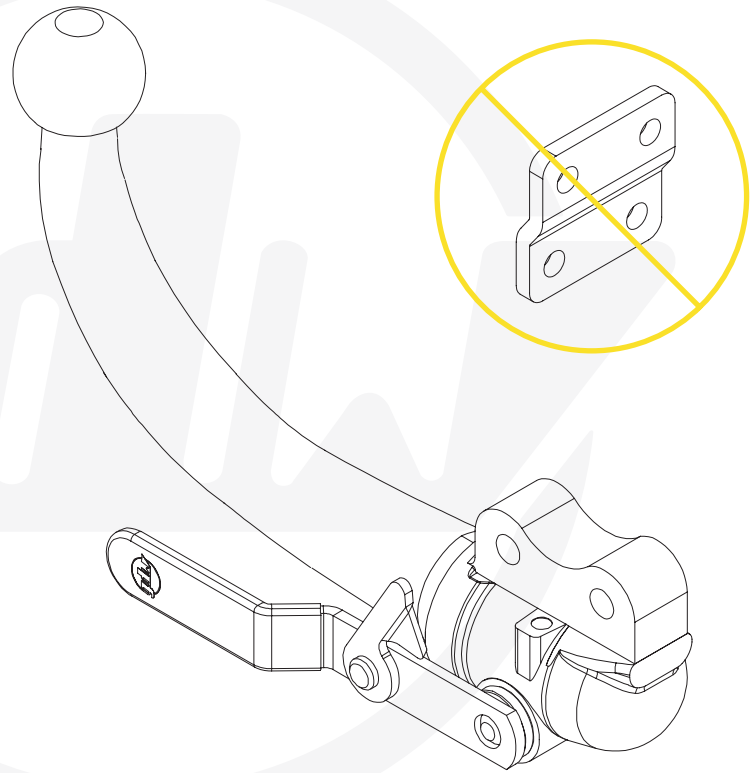

OPTION T36



x1

KIT36-2725

DICHIARAZIONE DI CORRETTO MONTAGGIO

DECLARATION OF CORRECT INSTALLATION

La sottoscritta ditta dichiara di aver montato in maniera corretta il dispositivo di traino di cui sotto, **seguendo le prescrizioni del costruttore del veicolo e del costruttore del dispositivo.**

The undersigned company declares to have correctly mounted the towing device mentioned below, following the prescriptions of the vehicle manufacturer and the construction manufacturer.

| | | |
|-------------------------|--------------|-----------------------------|
| COSTRUTTORE | MANUFACTURER | GDW N.V. |
| RIFERIMENTO | REFERENCE | 2725-2725T36 |
| AUTOVEICOLO | VEHICLE | NISSAN ARIYA 07/'21- |
| CLASSE E TIPO DI ATTACO | CLASS | F |
| APPROVAZIONE | HOMOLOGATION | E6*55R02/01*1766*00 |
| VALORE D | D VALUE | 9,50 kN |

Timbro e firma dell'installatore
Stamp & signature of installer

DATA

DATE

| | | |
|-------------------------|----------------------|--|
| MASSA RIMORCHIABILE | TOWABLE MASS | Vedere carta circolazione del veicolo See registration certificate of vehicle |
| CARICO VERTICALE MAX. S | MAX. VERTICAL LOAD S | 80 kg |

Per facilitare il controllo della compatibilità del dispositivo di traino sul veicolo, è opportuno confrontare le masse riportate sulla carta di circolazione del veicolo con le masse di riferimento sotto riportate (**T** ed **C**):

To simplify checking the compatibility of the towing device on the vehicle, it is advisable to compare the masses shown on the vehicle registration certificate with the reference masses shown below (T and C):

T = Massa complessiva del veicolo in kg Total vehicle mass in kg

C = Massa rimorchiabile del veicolo in kg Towable mass of the vehicle in kg

Massa complessiva del veicolo, desunta dalla carta di circolazione (**F2**) in kg

Total mass of the vehicle, taken from the registration certificate (F2)

deve essere inferiore od uguale a quella di riferimento **T** (= kg)

must be less than or equal to the reference T

Massa rimorchiabile del veicolo, desunta dalla carta di circolazione (**O1**) in kg

Towable mass of the vehicle, taken from the registration certificate (O1)

deve essere inferiore od uguale a quella di riferimento **C** (= kg)

must be less than or equal to the reference C

Se tali condizioni sono verificate il dispositivo **è installabile.** *If these conditions are met, the device can be installed.*

Se tali condizioni non si verificano, si deve procedere al seguente calcolo:

If these conditions are not met, the following calculation must be made:

$$D = \frac{T \times C}{T + C} \times 0,00981 = \dots\dots\dots \text{ kN}$$

Se **D** risulta inferiore a
If D is less than

9,50 kN

(valore riportato sulla targhetta e sul presente documento) il dispositivo **può essere installato.**
(value shown on the plate and on this document) the device can be installed.

NOTA ESPLICATIVA
EXPLANATORY NOTE

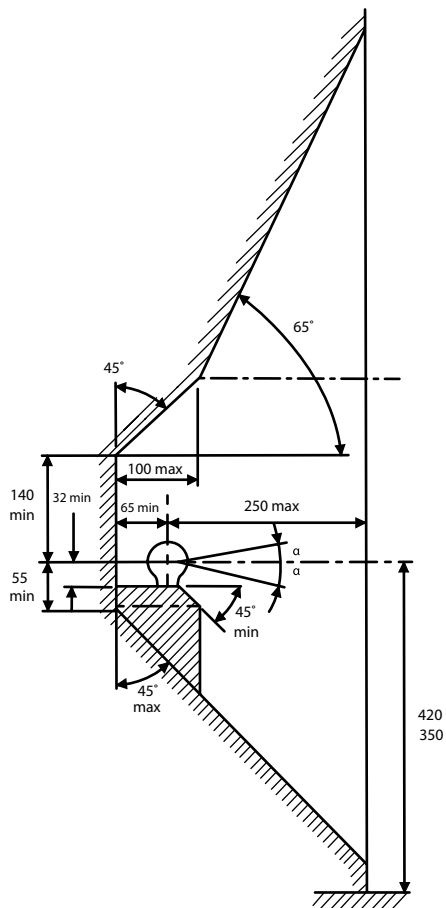

De tussenruimte conform bijlage VII, afbeelding 25 (a, b) van het reglement R55 UN/ECE moet in acht genomen worden. Deze voorschriften zijn niet van toepassing op terreinvoertuigen klasse G.

La zone de dégagement doit être garantie conformément à l'annexe VII, illustration 25 (a, b) de la règle R55 UN/ECE. Ces dispositions ne s'appliquent pas aux véhicules tout-terrain classe G.

The clearance specified in appendix VII, diagram 25 (a, b) of regulation R55 UN/ECE must be guaranteed. These requirements shall not apply to all-terrain vehicles class G.

Der Freiraum nach Anhang VII, Abbildung 25 (a, b) der Regulierung R55 UN/ECE ist zu gewährleisten. Diese Vorschriften gelten nicht für Geländefahrzeuge Klasse G.

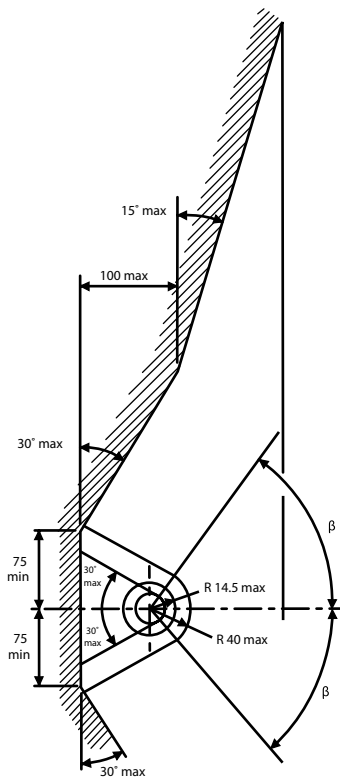

Bij toelaatbaar gewicht van het voertuig

Pour poids total en charge autorisé du véhicule

At laden weight of the vehicle

Bei zulässigem Gesamtgewicht des Fahrzeuges

Peso total admisible del vehículo

Ved tilladt samlet vægt for køretøjet

Peso totale ammissibile del veicolo